









Thru-beam Mode (DC)

Ag: RP76 SERIES

Sensing Mode	Connection	Supply Voltage	Output Mode	Part Number
Infrared:880nm	Terminal 	10-30V DC	Emitter	RP76-T028MD-EY9T4L
			NPN	RP76-T028MN-CY9T4U
			PNP	RP76-T028MP-CY9T4U
			NPN/PNP	RP76-T028MD-CY9T4U
			NPN , Timing delay	RP76-T028MN-CY9T4U-T
			PNP , Timing delay	RP76-T028MP-CY9T4U-T
			NPN/PNP,Timing delay	RP76-T028MD-CY9T4U-T
	Quick Disconnect (0°or90°settled) 	10-30V DC (Euro Style)	Emitter	RP76-T028MD-EY9Q4LE
			NPN	RP76-T028MN-CY9Q4UE
			PNP	RP76-T028MP-CY9Q4UE
			NPN/PNP	RP76-T028MD-CY9Q4UE
			NPN , Timing delay	RP76-T028MN-CY9Q4UE-T
			PNP , Timing delay	RP76-T028MP-CY9Q4UE-T
			NPN/PNP,Timing delay	RP76-T028MD-CY9Q4UE-T
Thru-beam Mode Sensing Distance: 28m	Quick Disconnect swivel 90° 	10-30V DC (Euro Style)	Emitter	RP76-T028MD-EY9Q4LE-S
			NPN	RP76-T028MN-CY9Q4UE-S
			PNP	RP76-T028MP-CY9Q4UE-S
			NPN/PNP	RP76-T028MD-CY9Q4UE-S
			NPN , Timing delay	RP76-T028MN-CY9Q4UE-TS
			PNP , Timing delay	RP76-T028MP-CY9Q4UE-TS
			NPN/PNP,Timing delay	RP76-T028MD-CY9Q4UE-TS
	6" Pigtail 	10-30V DC (Euro Style)	Emitter	RP76-T028MD-EY9P4LE
			NPN	RP76-T028MN-CY9P4UE
			PNP	RP76-T028MP-CY9P4UE
			NPN/PNP	RP76-T028MD-CY9P4UE
			NPN , Timing delay	RP76-T028MN-CY9P4UE-T
			PNP , Timing delay	RP76-T028MP-CY9P4UE-T
			NPN/PNP,Timing delay	RP76-T028MD-CY9P4UE-T

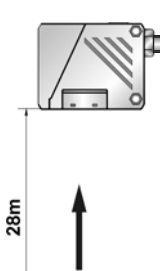
Note:
 Coming Soon : Part numbers with underline
 In Preparation: Part numbers with a line through the middle
 — Ag-01 —

Thru-beam Mode (AC/DC)





Sensing Mode	Connection	Supply Voltage	Output Mode	Part Number
Infrared: 880nm 	Terminal 	12-240V DC/ 24-240V AC	Emitter (2-wire)	RP76-T028MA-EY9T4L
			Relay NO (4-wire)	RP76-T028MR-CY9T4L
			Relay NO, Timing delay (4-wire)	RP76-T028MR-CY9T4L-T
			SPST Solid-state Light-ON/Dark-ON (2-wire)	
	Quick Disconnect (0° or 90° settled) 	12-240V DC/ 24-240V AC (Micro Style)	Emitter (2-wire)	RP76-T028MA-EY9Q4LM
			Relay NO (4-wire)	RP76-T028MR-CY9Q4LM
			Relay NO, Timing delay (4-wire)	RP76-T028MR-CY9Q4LM-T
			SPST Solid-state Light-ON/Dark-ON (2-wire)	
	Quick Disconnect swivel 90° 	12-240V DC/ 24-240V AC (Micro Style)	Emitter (2-wire)	RP76-T028MA-EY9Q4LM-S
			Relay NO (4-wire)	RP76-T028MR-CY9Q4LM-S
			Relay NO, Timing delay (4-wire)	RP76-T028MR-CY9Q4LM-TS
			SPST Solid-state Light-ON/Dark-ON (2-wire)	
Thru-beam Mode Sensing Distance: 28m	6" Pigtail 	12-240V DC/ 24-240V AC (Micro Style)	Emitter (2-wire)	RP76-T028MA-EY9P4LM
			Relay NO (4-wire)	RP76-T028MR-CY9P4LM
			Relay NO, Timing delay (4-wire)	RP76-T028MR-CY9P4LM-T
			SPST Solid-state Light-ON/Dark-ON (2-wire)	

Note:
 Coming Soon : Part numbers with underline
 In Preparation: Part numbers with a line through the middle
 — Ag-02 —

Ag: RP76 SERIES

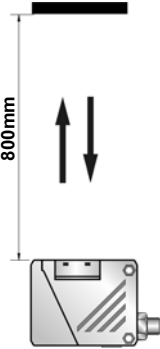
Diffuse Mode





Ag: RP76 SERIES

Sensing Mode	Connection	Supply Voltage	Output Mode	Part Number	
<p style="text-align: center;">Infrared: 880nm</p>  <p style="text-align: center;">800mm</p> <p style="text-align: center;">Diffuse Mode Sensing Distance: 800mm</p>	Terminal 	10-30V DC	NPN	RP76-D0800N-CY9T4U	
			PNP	RP76-D0800P-CY9T4U	
			NPN/PNP	RP76-D0800D-CY9T4U	
			NPN , Timing delay	RP76-D0800N-CY9T4U-T	
			PNP , Timing delay	RP76-D0800P-CY9T4U-T	
			NPN/PNP, Timing delay	RP76-D0800D-CY9T4U-T	
	12-240V DC/ 24-240V AC	Relay NO (4-wire) Relay NO, Timing delay (4-wire) SPST Solid-state L.O./D.O. (2-wire)			RP76-D0800R-CY9T4L
					RP76-D0800R-CY9T4L-T
	Quick Disconnect (0° or 90° settled) 	10-30V DC (Euro Style)	NPN	RP76-D0800N-CY9Q4UE	
			PNP	RP76-D0800P-CY9Q4UE	
			NPN/PNP	RP76-D0800D-CY9Q4UE	
			NPN , Timing delay	RP76-D0800N-CY9Q4UE-T	
			PNP , Timing delay	RP76-D0800P-CY9Q4UE-T	
			NPN/PNP, Timing delay	RP76-D0800D-CY9Q4UE-T	
	12-240V DC/ 24-240V AC (Micro Style)	Relay NO (4-wire) Relay NO, Timing delay (4-wire) SPST Solid-state L.O./D.O. (2-wire)			RP76-D0800R-CY9Q4LM
					RP76-D0800R-CY9Q4LM-T
	Quick Disconnect swivel 90° 	10-30V DC (Euro Style)	NPN	RP76-D0800N-CY9Q4UE-S	
			PNP	RP76-D0800P-CY9Q4UE-S	
			NPN/PNP	RP76-D0800D-CY9Q4UE-S	
			NPN , Timing delay	RP76-D0800N-CY9Q4UE-TS	
			PNP , Timing delay	RP76-D0800P-CY9Q4UE-TS	
			NPN/PNP, Timing delay	RP76-D0800D-CY9Q4UE-TS	
12-240V DC/ 24-240V AC (Micro Style)	Relay NO (4-wire) Relay NO, Timing delay (4-wire) SPST Solid-state L.O./D.O. (2-wire)			RP76-D0800R-CY9Q4LM-S	
				RP76-D0800R-CY9Q4LM-TS	
6" Pigtail 	10-30V DC (Euro Style)	NPN	RP76-D0800N-CY9P4UE		
		PNP	RP76-D0800P-CY9P4UE		
		NPN/PNP	RP76-D0800D-CY9P4UE		
		NPN , Timing delay	RP76-D0800N-CY9P4UE-T		
		PNP , Timing delay	RP76-D0800P-CY9P4UE-T		
		NPN/PNP, Timing delay	RP76-D0800D-CY9P4UE-T		
	12-240V DC/ 24-240V AC (Micro Style)	Relay NO (4-wire) Relay NO, Timing delay (4-wire) SPST Solid-state L.O./D.O. (2-wire)			RP76-D0800R-CY9P4LM
					RP76-D0800R-CY9P4LM-T

Note:

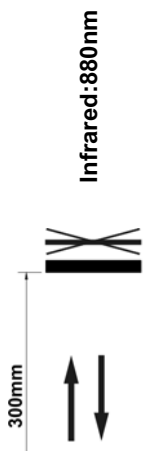
Coming Soon : Part numbers with underline
 In Preparation: Part numbers with a line through the middle
 —Ag-03—

Diffuse Mode with Background Suppression





Sensing Mode	Connection	Supply Voltage	Output Mode	Part Number
<p style="text-align: center;">Infrared: 880nm</p>  <p style="text-align: center;">300mm</p> <p style="text-align: center;">Diffuse Mode with Background Suppression Sensing Distance: 300mm</p>	Terminal 	10-30V DC	NPN	RP76-D0300N-CY9T4U-BS
			PNP	RP76-D0300P-CY9T4U-BS
			NPN/PNP	RP76-D0300D-CY9T4U-BS
			NPN , Timing delay	RP76-D0300N-CY9T4U-BT
			PNP , Timing delay	RP76-D0300P-CY9T4U-BT
			NPN/PNP, Timing delay	RP76-D0300D-CY9T4U-BT
	QuickDisconnect (0°or90°settled) 	10-30V DC (Euro Style)	NPN	RP76-D0300N-CY9Q4UE-BS
			PNP	RP76-D0300P-CY9Q4UE-BS
			NPN/PNP	RP76-D0300D-CY9Q4UE-BS
			NPN , Timing delay	RP76-D0300N-CY9Q4UE-BT
			PNP , Timing delay	RP76-D0300P-CY9Q4UE-BT
			NPN/PNP, Timing delay	RP76-D0300D-CY9Q4UE-BT
	Quick Disconnect swivel 90° 	10-30V DC (Euro Style)	NPN	RP76-D0300N-CY9Q4UE-SB
			PNP	RP76-D0300P-CY9Q4UE-SB
			NPN/PNP	RP76-D0300D-CY9Q4UE-SB
			NPN , Timing delay	RP76-D0300N-CY9Q4UE-TB
			PNP , Timing delay	RP76-D0300P-CY9Q4UE-TB
			NPN/PNP, Timing delay	RP76-D0300D-CY9Q4UE-TB
	6" Pigtail 	10-30V DC (Euro Style)	NPN	RP76-D0300N-CY9P4UE-BS
			PNP	RP76-D0300P-CY9P4UE-BS
			NPN/PNP	RP76-D0300D-CY9P4UE-BS
			NPN , Timing delay	RP76-D0300N-CY9P4UE-BT
			PNP , Timing delay	RP76-D0300P-CY9P4UE-BT
			NPN/PNP, Timing delay	RP76-D0300D-CY9P4UE-BT
	12-240V DC/ 24-240V AC (Micro Style)	Relay NO (4-wire)	RP76-D0300R-CY9T4L-BS	
		Relay NO, Timing delay (4-wire)	RP76-D0300R-CY9T4L-BT	
		SPST Solid-state L.O./D.O. (2-wire)		
		Relay NO (4-wire)	RP76-D0300R-CY9Q4LM-BS	
		Relay NO, Timing delay (4-wire)	RP76-D0300R-CY9Q4LM-BT	
		SPST Solid-state L.O./D.O. (2-wire)		
	12-240V DC/ 24-240V AC (Micro Style)	Relay NO (4-wire)	RP76-D0300R-CY9Q4LM-SB	
		Relay NO, Timing delay (4-wire)	RP76-D0300R-CY9Q4LM-TB	
		SPST Solid-state L.O./D.O. (2-wire)		
		Relay NO (4-wire)	RP76-D0300R-CY9P4LM-BS	
		Relay NO, Timing delay (4-wire)	RP76-D0300R-CY9P4LM-BT	
		SPST Solid-state L.O./D.O. (2-wire)		

Note:
 Coming Soon : Part numbers with underline
 In Preparation: Part numbers with a line through the middle
 —Ag-04—

Ag: RP76 SERIES

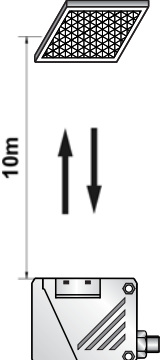





Retroreflective Mode with Polarizing Filter

Ag: RP76 SERIES

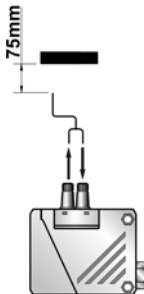
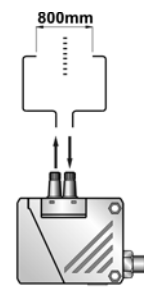
Sensing Mode	Connection	Supply Voltage	Output Mode	Part Number
<p style="text-align: center;">LED red:660nm</p>  <p style="text-align: center;">10m</p> <p style="text-align: center;">Retro-reflective Mode with Polarizing Filter Sensing Distance:10m (Note)</p>	<p>Terminal</p> 	10-30V DC	NPN	RP76-L010MN-CY6T4U-PF
			PNP	RP76-L010MP-CY6T4U-PF
			NPN/PNP	RP76-L010MD-CY6T4U-PF
			NPN , Timing delay	RP76-L010MN-CY6T4U-TP
			PNP , Timing delay	RP76-L010MP-CY6T4U-TP
			NPN/PNP,Timing delay	RP76-L010MD-CY6T4U-TP
	12-240V DC/ 24-240V AC	Relay NO (4-wire)	RP76-L010MR-CY6T4L-PF	
		Relay NO, Timing delay (4-wire)	RP76-L010MR-CY6T4L-TP	
		SPST Solid-state L.O./D.O. (2-wire)		
	<p>QuickDisconnect(0°or90°settled)</p> 	10-30V DC (Euro Style)	NPN	RP76-L010MN-CY6Q4UE-PF
			PNP	RP76-L010MP-CY6Q4UE-PF
			NPN/PNP	RP76-L010MD-CY6Q4UE-PF
			NPN , Timing delay	RP76-L010MN-CY6Q4UE-TP
			PNP , Timing delay	RP76-L010MP-CY6Q4UE-TP
			NPN/PNP,Timing delay	RP76-L010MD-CY6Q4UE-TP
	12-240V DC/ 24-240V AC (Micro Style)	Relay NO (4-wire)	RP76-L010MR-CY6Q4LM-PF	
		Relay NO, Timing delay (4-wire)	RP76-L010MR-CY6Q4LM-TP	
		SPST Solid-state L.O./D.O. (2-wire)		
	<p>Quick Disconnect swivel 90°</p> 	10-30V DC (Euro Style)	NPN	RP76-L010MN-CY6Q4UE-PS
			PNP	RP76-L010MP-CY6Q4UE-PS
			NPN/PNP	RP76-L010MD-CY6Q4UE-PS
			NPN , Timing delay	RP76-L010MN-CY6Q4UE-PT
			PNP , Timing delay	RP76-L010MP-CY6Q4UE-PT
			NPN/PNP,Timing delay	RP76-L010MD-CY6Q4UE-PT
12-240V DC/ 24-240V AC (Micro Style)	Relay NO (4-wire)	RP76-L010MR-CY6Q4LM-PS		
	Relay NO, Timing delay (4-wire)	RP76-L010MR-CY6Q4LM-PT		
	SPST Solid-state L.O./D.O. (2-wire)			
<p>6" Pigtail</p> 	10-30V DC (Euro Style)	NPN	RP76-L010MN-CY6P4UE-PF	
		PNP	RP76-L010MP-CY6P4UE-PF	
		NPN/PNP	RP76-L010MD-CY6P4UE-PF	
		NPN , Timing delay	RP76-L010MN-CY6P4UE-TP	
		PNP , Timing delay	RP76-L010MP-CY6P4UE-TP	
		NPN/PNP,Timing delay	RP76-L010MD-CY6P4UE-TP	
	12-240V DC/ 24-240V AC (Micro Style)	Relay NO (4-wire)	RP76-L010MR-CY6P4LM-PF	
		Relay NO, Timing delay (4-wire)	RP76-L010MR-CY6P4LM-TP	
		SPST Solid-state L.O./D.O. (2-wire)		

Note: Used with RE-6152 (supplied with sensor) reflector.
In Preparation: Part numbers with a line through the middle

Glass Fiber Optic Mode

Sensing Mode	Connection	Supply Voltage	Output Mode	Part Number			
<p>LED red:660nm</p>  <p>800mm</p>  <p>75mm</p>  <p>Glass Fiber-optic Sensing Distance (Note)</p>	Terminal	10-30V DC	NPN	RP76-FGFN-CY6T4U			
			10-30V DC	PNP	RP76-FGFP-CY6T4U		
				NPN/PNP	RP76-FGFD-CY6T4U		
				NPN , Timing delay	RP76-FGFN-CY6T4U-T		
				PNP , Timing delay	RP76-FGFP-CY6T4U-T		
				NPN/PNP, Timing delay	RP76-FGFD-CY6T4U-T		
		12-240V DC/ 24-240V AC		Relay NO (4-wire)	RP76-FGFR-CY6T4L		
	<p>Quick Disconnect (0° or 90° settled)</p> 	10-30V DC (Euro Style)	Relay NO, Timing delay (4-wire)	RP76-FGFR-CY6T4L-T			
			10-30V DC (Euro Style)	SPST Solid-state L.O./D.O. (2-wire)			
				NPN	RP76-FGFN-CY6Q4UE		
				PNP	RP76-FGFP-CY6Q4UE		
				NPN/PNP	RP76-FGFD-CY6Q4UE		
				NPN , Timing delay	RP76-FGFN-CY6Q4UE-T		
	PNP , Timing delay	RP76-FGFP-CY6Q4UE-T					
	<p>Quick Disconnect swivel 90°</p> 	10-30V DC (Euro Style)	NPN/PNP, Timing delay	RP76-FGFD-CY6Q4UE-T			
			10-30V DC (Euro Style)	Relay NO (4-wire)	RP76-FGFR-CY6Q4LM		
				12-240V DC/ 24-240V AC (Micro Style)	Relay NO, Timing delay (4-wire)	RP76-FGFR-CY6Q4LM-T	
					12-240V DC/ 24-240V AC (Micro Style)	SPST Solid-state L.O./D.O. (2-wire)	
						NPN	RP76-FGFN-CY6Q4UE-S
						PNP	RP76-FGFP-CY6Q4UE-S
	NPN/PNP	RP76-FGFD-CY6Q4UE-S					
	NPN , Timing delay	RP76-FGFN-CY6Q4UE-TS					
	PNP , Timing delay	RP76-FGFP-CY6Q4UE-TS					
	NPN/PNP, Timing delay	RP76-FGFD-CY6Q4UE-TS					
<p>6" Pigtail</p> 	10-30V DC (Euro Style)	Relay NO (4-wire)	RP76-FGFR-CY6Q4LM-S				
		10-30V DC (Euro Style)	Relay NO, Timing delay (4-wire)	RP76-FGFR-CY6Q4LM-TS			
			12-240V DC/ 24-240V AC (Micro Style)	SPST Solid-state L.O./D.O. (2-wire)			
				12-240V DC/ 24-240V AC (Micro Style)	NPN	RP76-FGFN-CY6P4UE	
					12-240V DC/ 24-240V AC (Micro Style)	PNP	RP76-FGFP-CY6P4UE
						12-240V DC/ 24-240V AC (Micro Style)	NPN/PNP
	12-240V DC/ 24-240V AC (Micro Style)						NPN , Timing delay
		12-240V DC/ 24-240V AC (Micro Style)					PNP , Timing delay
			12-240V DC/ 24-240V AC (Micro Style)				NPN/PNP, Timing delay
				12-240V DC/ 24-240V AC (Micro Style)			Relay NO (4-wire)
					12-240V DC/ 24-240V AC (Micro Style)		Relay NO, Timing delay (4-wire)
						12-240V DC/ 24-240V AC (Micro Style)	SPST Solid-state L.O./D.O. (2-wire)

Note: Depends on fiber optic used (Please see our Glass Fiber & Plastic Fiber catalogue for detail information).
 In Preparation: Part numbers with a line through the middle

Specifications (DC)

Item \ Sensing Mode	Thru-beam	Retroreflective (with polarizing filter)	Standard Diffuse	Diffuse (background suppression)	Glass Fiber Optic
Sensing Range, Adjustable	28m	10m (Note)	800 mm	300 mm	Depends on fiber optic used
Angle of Divergence	approx. 1°	approx. 1.7°	approx. 1.1°	approx. 1.7°	——
Light Spot Size	350mm@20m	150mm@5m	15mm@800mm	17mm@300mm	——
Light Source	Infrared 880nm	Red Light 660nm	Infrared 880nm	Infrared 880nm	Red Light 660nm
Response Time/Frequency	<=1ms/500Hz			<=2ms/250Hz	<=1ms/500Hz
Supply Voltage	10-30V DC (limit values)				
Current Consumption (no load)	<35 mA				
Ripple (within Vs tolerance)	<= 5 V peak-to-peak				
Indicator LED	Yellow: Power, Green: Output, Red: Margin (Emitter of thru-beam mode: Red LED)				
Output Type	PNP, NPN, PNP/NPN				
Output Voltage High	PNP is Vs-(<=2.5V); NPN is approx. Vs				
Output Voltage Low	PNP is approx. 0V; NPN is <=1.5V				
Output Current Max.	100 mA				
Operation Mode	Light or dark switching selectable via switch				
Housing Material	ABS				
Enclosure Rating	IP 66 / NEMA 4				
Circuit Protection	Outputs short circuit and over current protected, Vs reverse polarity protected				
Test Input	0 V: light source off; VS or no connection: light source on (only for thru-beam mode)				
Time Options	No delay, On delay, Off delay, One-shot (with timer mode only)				
Time Settings	0.1 ... 5s Variable (with timer mode only)				
Ambient Operating Temperature	-25...55°C				
Storage Temperature	-40...70°C				
EMC	IEC 60947-5-2, Parts 7.2.6.1.2.3 or RFI>3V/m (in 80-1000MHz), EFT>1KV, ESD>4KV(contact)				
Voltage With Stand Ability	IEC 60947-5-2, Part 8.3.3.4 or 500VDC for one min, between all supply terminals connected together and enclosure				
Insulation Resistance	>20M Ω, with 500V DC megger between all supply terminals connected together and enclosure				
Vibration Resistance	IEC 60947-5-2, Part 7.4.2 or 10-55HZ, 1.0mm amplitude in x, y and z directions for 30 min				
Shock Resistance	IEC 60947-5-2, Part 7.4.1 or 30g, 11ms in x, y and z directions for six time each				
Weight	Approx. 120 g				
Mounting Bracket	MB-7263 (optional)				
Pigtail Type	See our pigtail series or our Cables & Connectors catalogue				

Note: Used with RE-6152 (supplied with sensor) reflector.

Specifications (AC/DC)

Item \ Sensing Mode	Thru-beam	Retroreflective (with polarizing filter)	Standard Diffuse	Diffuse (background suppression)	Glass Fiber Optic
Sensing Range, Adjustable	28m	10m (Note)	800 mm	300 mm	Depends on fiber optic used
Angle of Divergence	approx.1°	approx.1.7°	approx.1.1°	approx.1.7°	——
Light Spot Size	350mm@20m	150mm@5m	15mm@800mm	17mm@300mm	——
Light Source	Infrared 880nm	Red Light 660nm	Infrared 880nm	Infrared 880nm	Red Light 660nm
Response Time / Frequency	<20 ms /25 Hz				
Supply Voltage	12-240V DC / 24-240V AC (10%)				
Power Consumption	< 2 VA				
Indicator LED	Yellow: Power, Green: Output, Red: Margin (Emitter of thru-beam mode: Red LED)				
Output Type	Relay NO isolated (provide arc suppression for inductive / capacitive loads), SPST Solid-state with either normally closed or normally open contact				
Switching Voltage Max.	240 V AC				
Switching Current Max.	3 A				
Current Consumption(No load)	< 30 mA				
Operation Mode	Light or dark switching selectable via switch				
Housing Material	ABS				
Enclosure Rating	IP 66 / NEMA 4				
Circuit Protection	Output short circuit protected (only for 2-wire type), Vs reverse polarity protected				
Time Options	No delay, On delay, Off delay, One-shot (with timer mode only)				
Time Settings	Adjustable, 0.1...5 s (with timer mode only)				
Ambient Operating Temperature	-25...55°C				
Storage Temperature	-40...70°C				
EMC	IEC 60947-5-2, Parts 7.2.6.1.2.3 or RFI>3V/m(in 30-1000MHz), EFT>1KV, ESD>4KV(contact)				
Voltage Withstand Ability	IEC 60947-5-2, Part 8.3.3.4 or 1500V AC for one min, between all supply terminals connected together and enclosure				
Insulation Resistance	>20MΩ , with 500V AC megger between all supply terminals connected together and enclosure				
Vibration Resistance	IEC 60947-5-2, Part 7.4.2 or 10-55HZ, 1.0mm amplitude in x , y and z directions for 30 min				
Shock Resistance	IEC 60947-5-2, Part 7.4.1 or 30g, 11ms in x , y and z directions for six time each				
Mounting Bracket	MB-7263 (optional)				
Weight	approx. 120 g				
Pig tail Type	See Pigtail Series or our Cables & Connector catalogue				

Note: Used with RE-6152 (supplied with sensor) reflector.

Connection Diagrams

Emitter of Thru-beam Mode (DC)

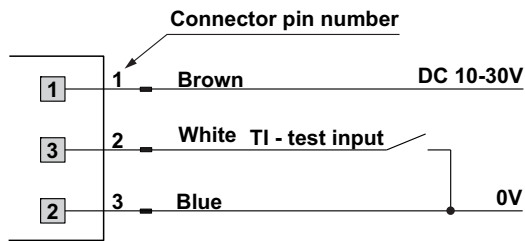

Connector pin position

Euro-style

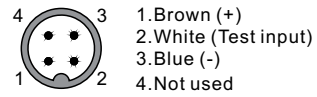

PNP output type

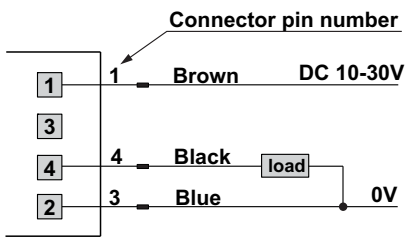

NPN output type

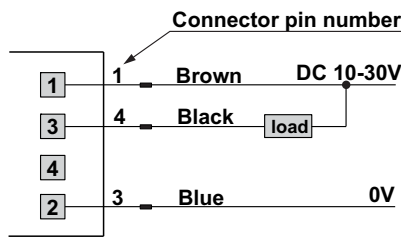

Connector pin position

Euro-style

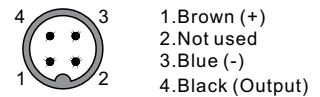

NPN/PNP output type

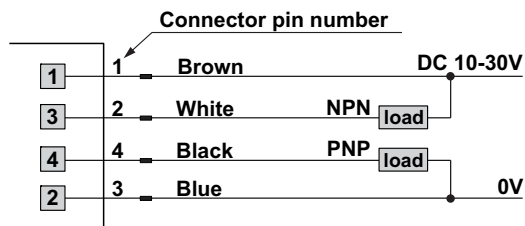

Connector pin position

Euro-style

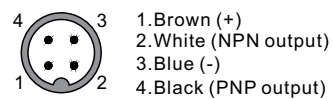

Emitter of Thru-beam Mode (AC/DC)

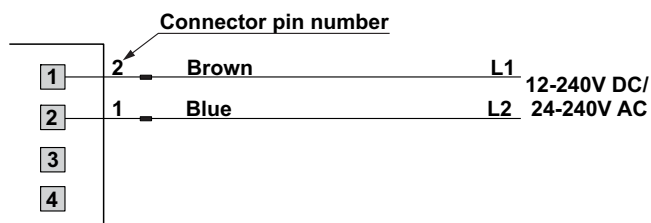

Connector pin position

Micro-style

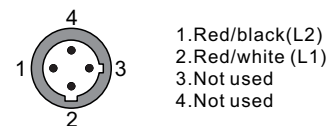

Relay output (AC/DC)

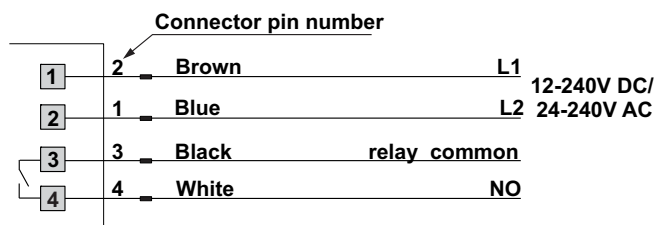

Connector pin position

Micro-style

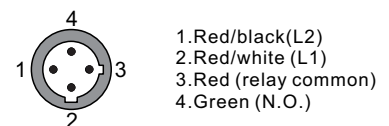

SPST Solid-state output (AC/DC)

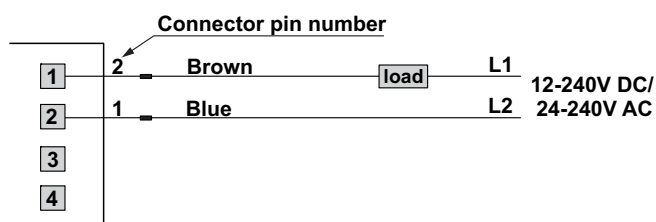

Connector pin position

Micro-style

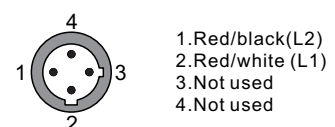

Sensing Characteristics (Typical)

Background Suppression Diffuse (Sn=300 mm)

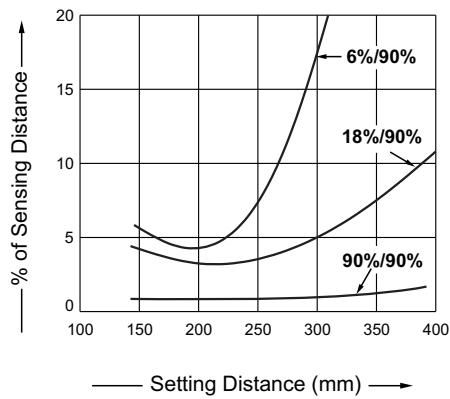

Diffuse Mode (Sn=800 mm)

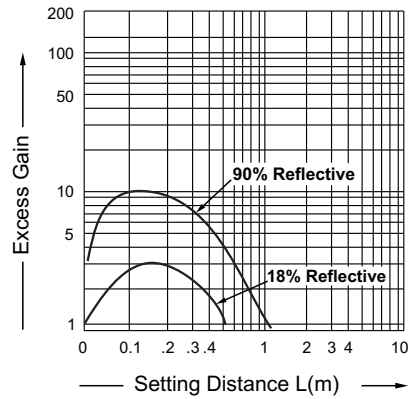

Polarized Retro-reflective Mode (Sn=10m)

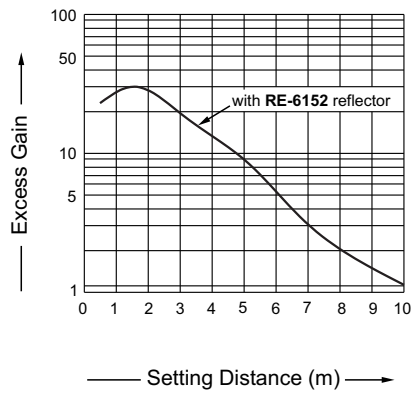

Thru-beam Mode (Sn=28 m)

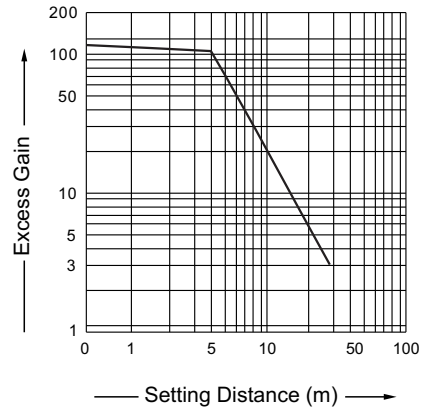

Glass Fiber-Optic Mode

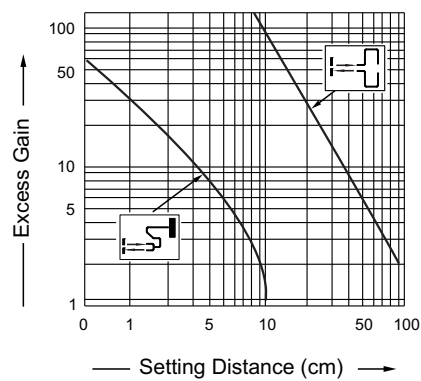

Ag: RP76 SERIES

Dimensions (Unit: mm)

Sensor Type

Terminal Type

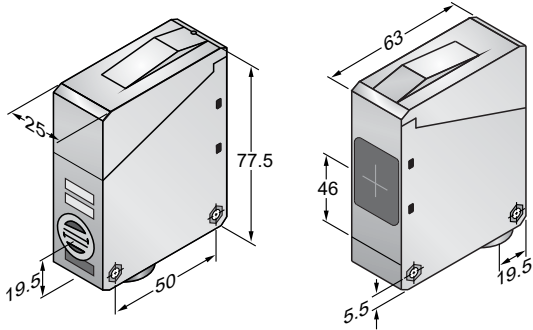

Quick Disconnect (0 or 90° settled)

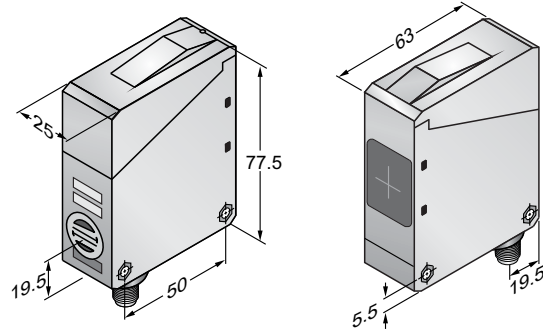

Quick Disconnect (Swivel 90°)

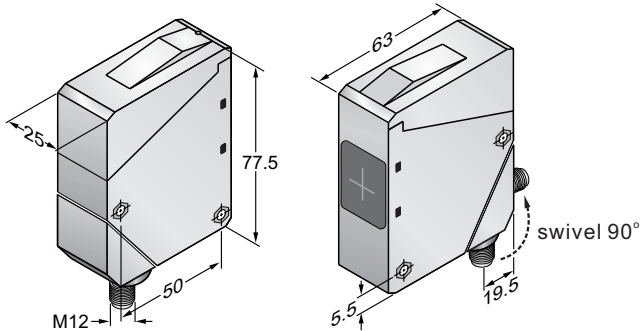

Pigtail* Type

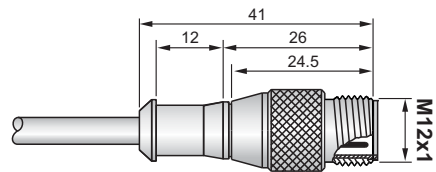

*: Please see **Pigtail Series** or our **Cables & Connectors** catalogue for more information.

Ag: RP76 SERIES

MB-7263 (Mounting bracket-optional)

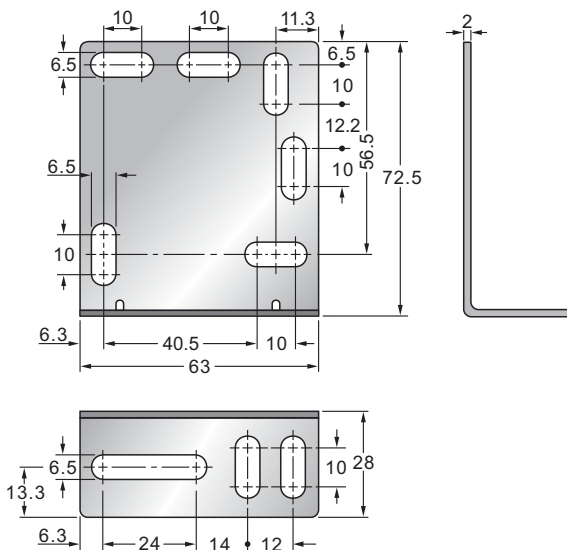

Timer Mode Panel

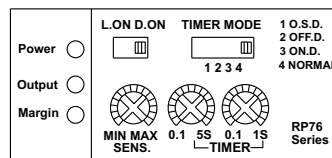

Terminal Type

